

DMX512

Decoder Series



CE RoHS

Specifications

Model:	DE8000		
Input:	DC12-24V	Max output Power:	144W(12V)/288W(24V)
Max current Load:	4A*3CH Max 12A	Signal Input:	DMX512/1990
Control channels:	3CH	The light gray level:	256
Protection Grade:	IP20	DMX512/PWM Socket:	RJ45/Screwless terminal
Gross Weight:	220g	Work Temp.:	-30°C~70°C

Basic Features

- Meets DMX512/1990, with RJ45 interface.
- 256-levels brightness, full-color with driver controls.
- Can achieve asynchronous color changes effect under working with controller.
- Cooperate with control system, can realize rich change effect.
- Setting the DMX address freely.

Dimensions

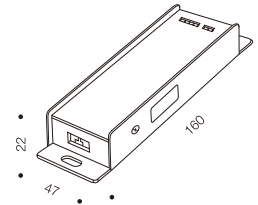

Unit: mm

Component Diagram

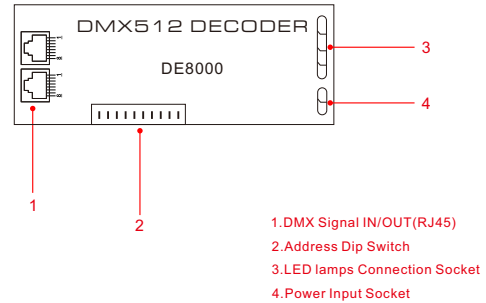

Product Operation

Self-testing Mode: put all DIP-Switch NO.1 to NO.9 ON full channels output 3 seconds then each color gradient.

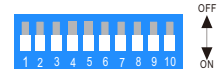

How to set DMX address via DIP switch:

DMX address value = the total value of (1-9)
to get the place value when in "on" position
otherwise will be 0.

E.g. 1 : Set Initial Address to 16.

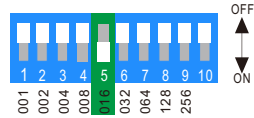

E.g. 2 : Set Initial Address to 20.

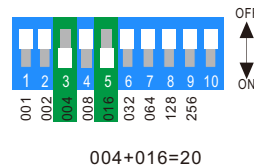

E.g. 3 : Set Initial Address to 149.

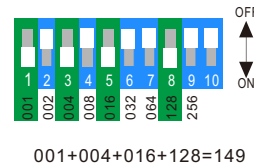

DMX Dimming Instruction:

Each DE8000 DMX decoder occupied 3 DMX addresses when connecting the DMX console.
E.g., the defaulted initial address is 1, please find their corresponding relationships in the form.

DMX Console	DMX Decoder
CH1 0-255	CH1 PWM 0-100% (LED R)
CH2 0-255	CH2 PWM 0-100% (LED G)
CH3 0-255	CH3 PWM 0-100% (LED B)

Wiring Diagram

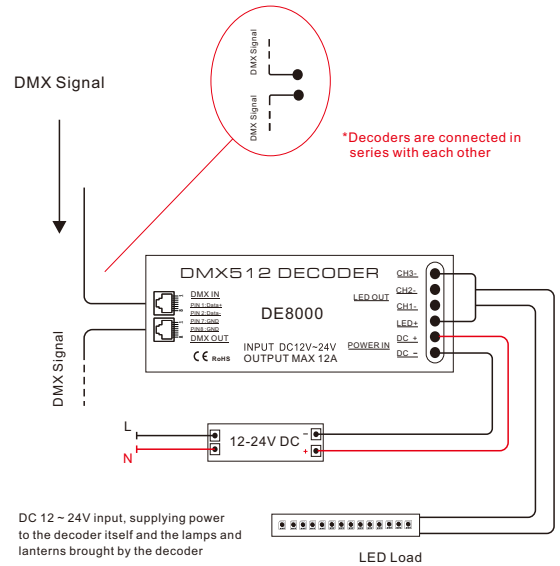

DC 12 ~ 24V input, supplying power to the decoder itself and the lamps and lanterns brought by the decoder

LED Load

*An amplifier is needed when more than 32 decoders are connected, signal amplification should not be more than 4 times continuously.

*At the end of the wiring, we should connect a DMX signal finalizer (Put ON the switch no.10 of DE8000 dial).

Suitable lamps and lanterns

